

Infrared Receiver Module EAIRMG2

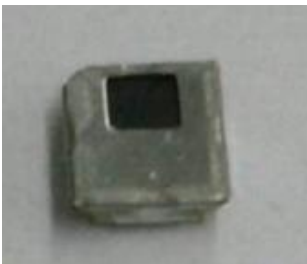

Block Diagram

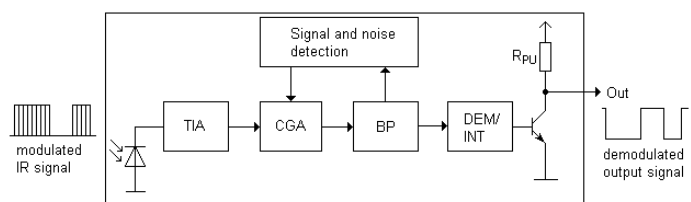

Features

- High protection ability against EMI
- Circular lens for improved reception characteristics
- Min burst length: 400us
- Min gap length: 450us
- Low operating voltage ($V_{cc} = 2.5V$)
- High immunity against ambient light
- Long reception range
- High sensitivity
- Pb free and RoHS compliant
- Compliance with EU REACH
- Compliance Halogen Free .(Br <900 ppm ,Cl <900 ppm , Br+Cl < 1500 ppm)

Descriptions

- The device is a miniature SMD type infrared remote control system receiver that has been developed and designed by utilizing the most updated IC technology.
- The PIN diode and preamplifier are assembled on PCB, the epoxy package is designed as an IR filter. The demodulated output signal can directly be decoded by a microprocessor.

Applications

- AV equipment such as TV, VCR, DVD, CD, MD, etc.
- Toy applications
- CATV set top boxes
- Multi-media Equipment

Application Circuit

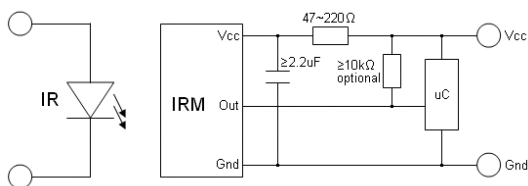

RC Filter should be connected closely between Vcc pin and GND pin.

Parts Table

Model No.	Carrier Frequency
EAIRMGA2	40 kHz

Absolute Maximum Ratings (Ta=25°C)

Parameter	Symbol	Rating	Unit	Notice
Supply Voltage	Vcc	6	V	
Operating Temperature	Topr	-20 ~ +80	°C	
Storage Temperature	Tstg	-40 ~ +85	°C	

Electro-Optical Characteristics (Ta=25°C , Vcc = 3V)

Parameter	Symbol	MIN.	TYP.	MAX.	Unit	Condition
Supply Current	I _{CC}	---	1.0	1.3	mA	No signal input
Supply Voltage	V _S	2.5	-	5.5	V	
Peak Wavelength	λ _p	---	940	---	nm	---
Reception Distance	L ₀	8	---	---	m	See chapter ,Test method'
	L ₄₅	5	---	---		
Half Angle(Horizontal)	Θ _h	---	45	---	deg	
Half Angle(Vertical)	Θ _v	---	45	---	deg	
High Level Pulse Width	T _H	450	---	750	μs	Test signal according to figure 1
Low Level Pulse Width	T _L	450	---	750	μs	
High Level Output Voltage	V _H	V _{CC} -0.4	---	---	V	
Low Level Output Voltage	V _L	---	0.2	0.5	V	I _{SINK} ≤ 2mA
Internal pull up resistor	R _{PU}	40	50	60	kΩ	

Test Method

The specified electro-optical characteristic is satisfied under the following Conditions:

1. Measurement environment

A place without extreme light reflected

2. External light

Ordinary white fluorescent lamps (Light source temperature 2856°K, $E_e \leq 10\text{Lux}$) without high frequency modulation

3. Standard transmitter

The test transmitter is calibrated by using the circuit shown in figure 2. The radiation intensity of the transmitter is adjusted until $V_o=400\text{mVp-p}$. Both, the test transmitter and the photo diode, have a peak wavelength of 940nm. The photo diode for calibration is PD438B ($\lambda_p=940\text{nm}$, $V_r=5\text{V}$).

4. Measuring system According to the measuring system shown in Fig.-3

Fig.-1 Transmitter Wave Form

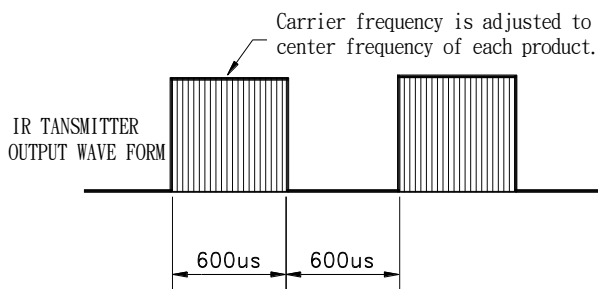

D.U.T output Pulse

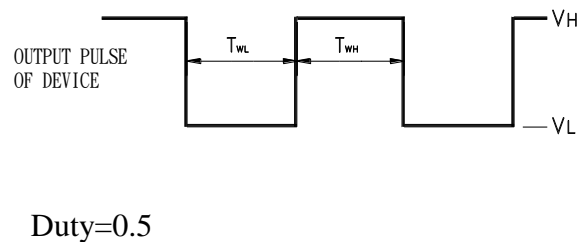

Fig.-2 Measuring Method

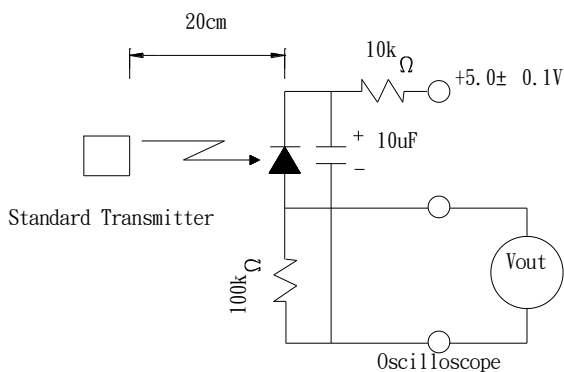
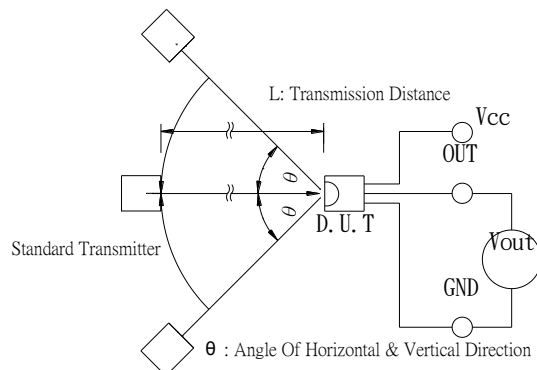

Fig.-3 Measuring System



Typical Electro-Optical Characteristics Curves

Fig.4 Relative Responsibility vs. Wavelength

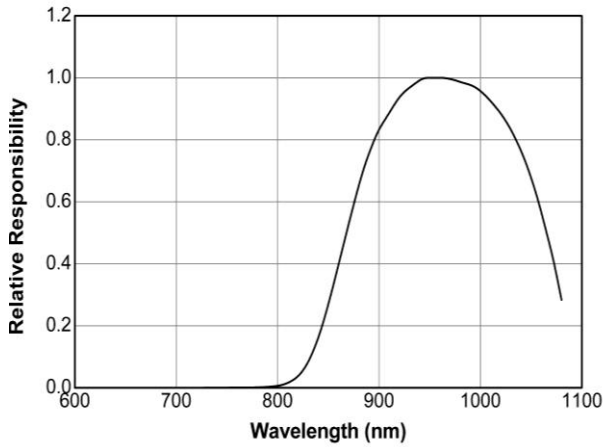

Fig.-5 Relative Sensitivity vs. Horizontal Angle

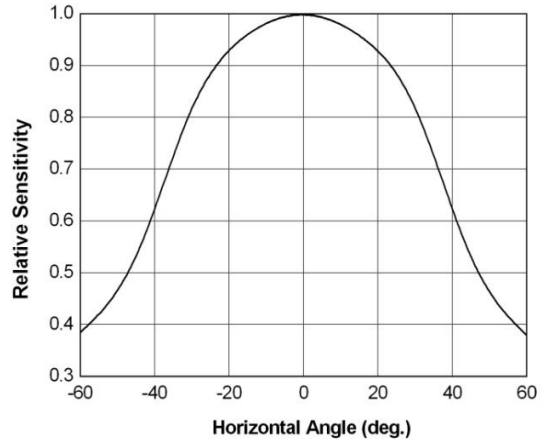

Fig.-7 Output Pulse Width vs. Transmission Distance

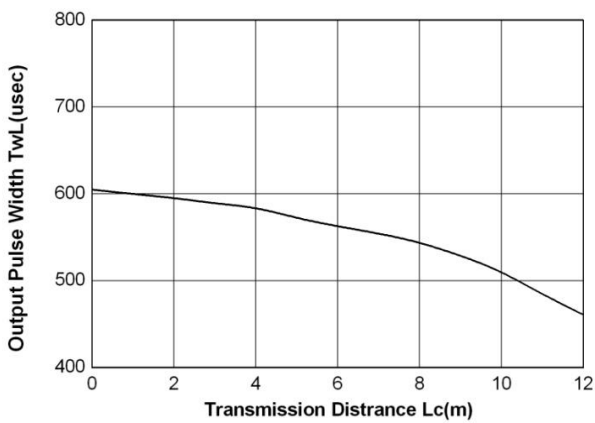

Fig.-7 Relative Transmission Distance vs. Supply Voltage

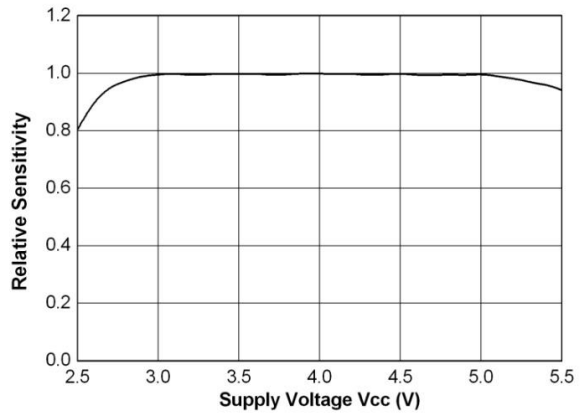
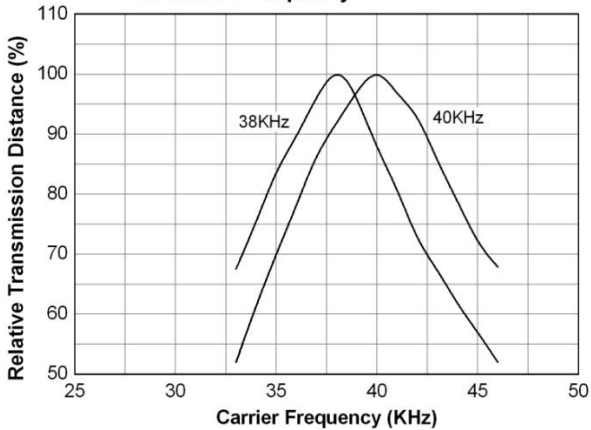
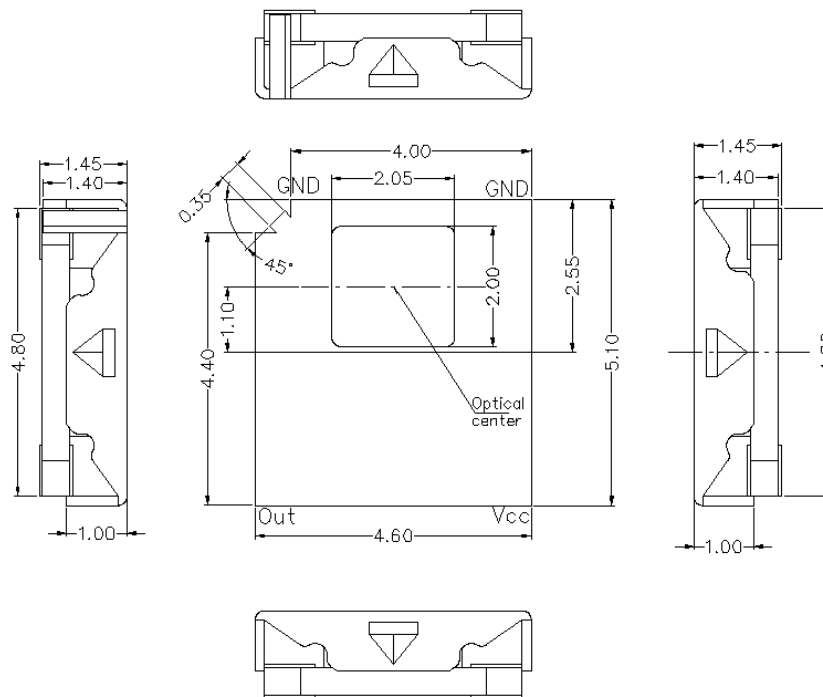

Fig.-8 Relative Transmission Distance vs. Carrier Frequency



Package Dimenstions

(Dimensions in mm)



Notes : Tolerances unless dimensions $\pm 0.3\text{mm}$.

Shield need contact GND pin on PCB.

Recommended pad layout for surface mount leadform

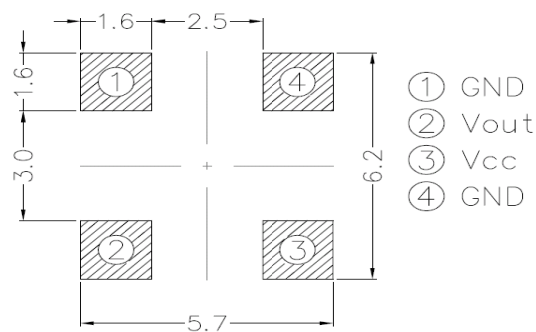

Code information

Protocol	Suitable	Protocol	Suitable
JVC	Yes	RCA	No
Matsushita	No	Sharp	No
Mitsubishi	No	Sony 12 Bit	Yes
NEC	Yes	Sony 15 Bit	Yes
RC5	Yes	Sony 20 Bit	No
RC6	Yes	Toshiba	Yes
RCMM	No	Zenith	Yes
RCS-80	No	Continuous Code	No

Tape & Reel Packing Specifications

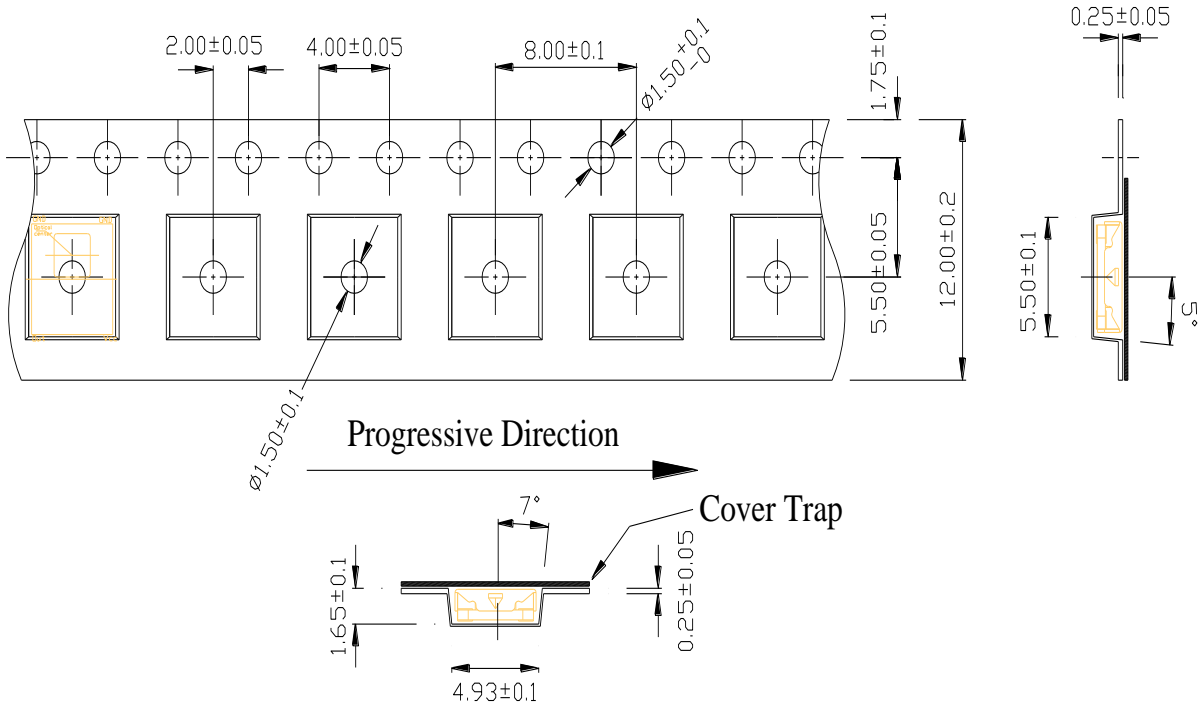

Packing Quantity

2000 pcs / Reel

5 Reels / Carton

Label format

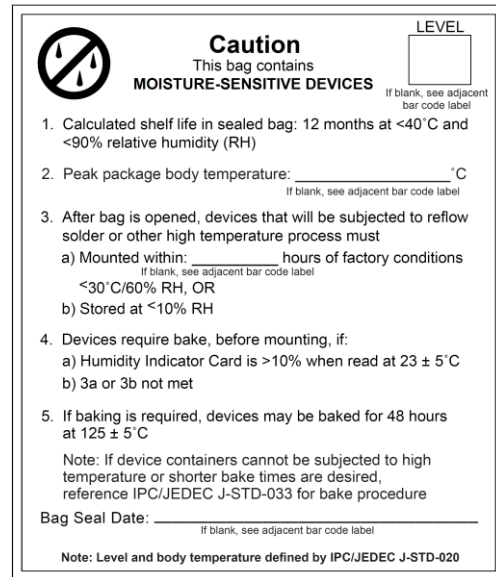
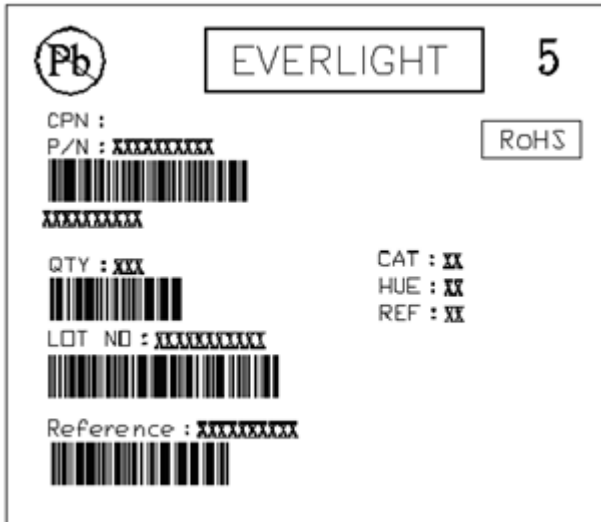

Moisture Classification-storage and used condition label

Recommended method of storage

The following are general recommendations for moisture sensitive level (MSL) 4 storage and use:

- Shelf life in sealed bag from the bag seal date: 12 months at <math><40^{\circ}\text{C}</math> and <math><90\%</math> relative humidity (RH)
- After bag is opened, devices that will be subjected to reflow solder or other high temperature process must be mounted within 72 hours of factory conditions <math><30^{\circ}\text{C}/60\%</math>RH.
- If the moisture absorbent material (silica gel) has faded away or the IRM has exceeded the storage time. Baking treatment is required, refer to IPC/JEDEC J-STD-033 for bake procedure or recommend the conditions: $60 \pm 5^{\circ}\text{C}$ for 96 hours.

ESD Precaution

Proper storage and handling procedures should be followed to prevent ESD damage to the devices especially when they are removed from the Anti-static bag. Electro-Static Sensitive Devices warning labels are on the packing.

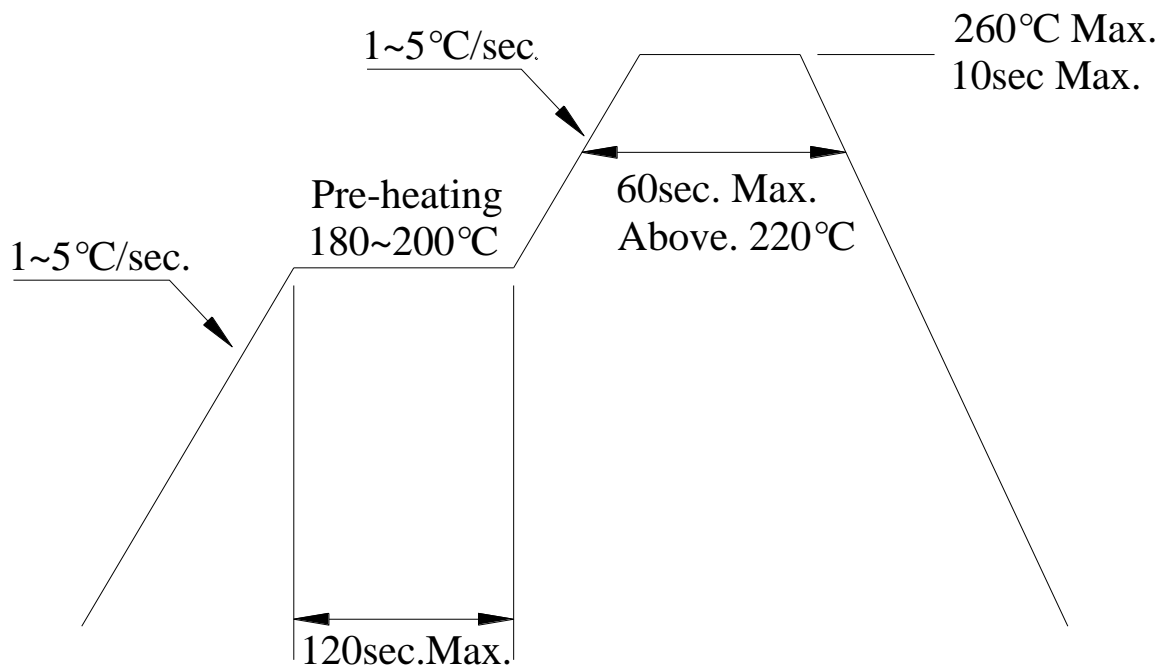
Solder Reflow Temperature Profile**Note:**

1. Reflow soldering should not be done more than two times.
2. When soldering, do not put stress on the IRM device during heating.
3. After soldering, do not warp the circuit board.

DISCLAIMER

1. Above specification may be changed without notice. Everlight Americas will reserve authority on material change for above specification.
2. When using this product, please observe the absolute maximum ratings and the instructions for use outlined in these specification sheets. Everlight Americas assumes no responsibility for any damage resulting from use of the product which does not comply with the absolute maximum ratings and the instructions included in these specification sheets.
3. These specification sheets include materials protected under copyright of Everlight Americas. Reproduction in any form is prohibited without the specific consent of Everlight Americas.