



Grayhill, Inc.

62S11-H9-060C

Număr parc: 62S11-H9-060C

Producator / Marca: Grayhill, Inc.

Descrierea produsului: ROTARY ENCODER OPTICAL 32PPR

Foi de date:  62S11-H9-060C.pdfStatutul RoHS:  Plumb fără RoHS / RoHS

Starea stocului: 2172 pcs stock

Barca din: Hong Kong

Calea de transport: DHL/Fedex/TNT/UPS/EMS

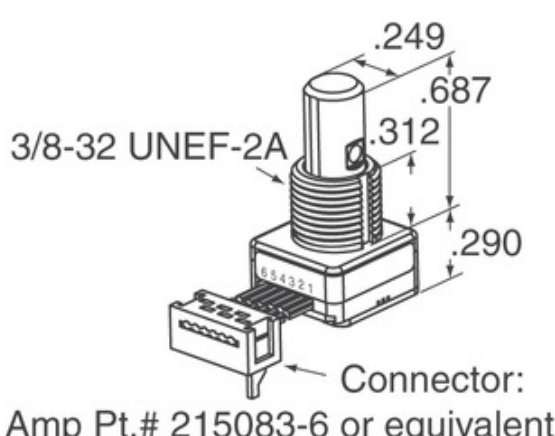

Imaginaea poate fi reprezentată. Vedeți specificațiile pentru detalii despre produs.

[CERERE DE OFERTĂ](#)

Specificațiile 62S11-H9-060C

NUMĂR PARC	62S11-H9-060C
PRODUCĂTOR	Grayhill, Inc.
DESCRIERE	ROTARY ENCODER OPTICAL 32PPR
CONDIȚII LIBERE DE STARE / STARE ROHS	Plumb fără RoHS / RoHS
CANTITATE VALABILA	2172 pcs
FIȘA CU DATE	 62S11-H9-060C.pdf
TENSIUNE - APROVIZIONARE	5V
STILUL DE TERMINARE	Cable with Connector
SERIE	62S
DURATA DE ROTAȚIE (CICLURI MIN)	1M
IMPULSURI PE REVOLUȚIE	32
TIPUL DE IEȘIRE	Quadrature (Incremental)
ALTE NUME	62S11H9060C
ORIENTARE	Vertical
TIPUL DE MONTARE	Panel Mount
NIVELUL DE SENSIBILITATE LA UMIDITATE (MSL)	1 (Unlimited)
CONDIȚII DE STARE FĂRĂ PLUMB / STARE ROHS	Lead free / RoHS Compliant
TIPUL ENCODERULUI	Optical
DETENTEI	Yes
CONSTRUIT ÎN SWITCH	Yes
TIPUL ACTUATORULUI	1/4" Dia Flatted End

Etichete asemănătoare

Grayhill, Inc. 62S11-H9-060C	Distribuitor 62S11-H9-060C	Furnizor 62S11-H9-060C
Prețul 62S11-H9-060C	Imagini 62S11-H9-060C	Imagine 62S11-H9-060C
62S11-H9-060C PDF Datasheet	62S11-H9-060C Download Datasheet	Fișa tehnică 62S11-H9-060C
62S11-H9-060C Stoc	Cumpărați 62S11-H9-060C	Cumpara Grayhill, Inc. 62S11-H9-060C
Grayhill, Inc. 62S11-H9-060C	Furnizor Grayhill, Inc.	Distribuitor Grayhill, Inc.
Grayhill, Inc. 62S11-H9-060C	Grayhill Inc. 62S11-H9-060C	

produse asemanatoare

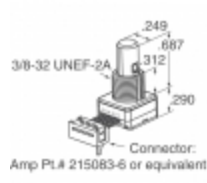
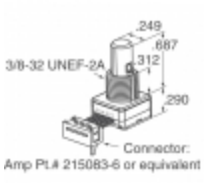
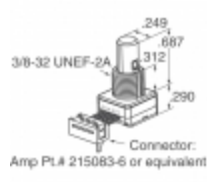
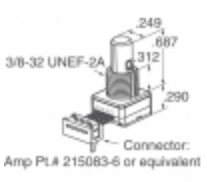
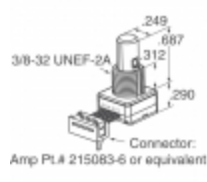
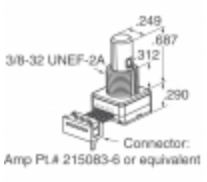
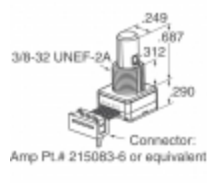
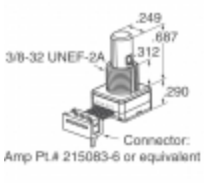
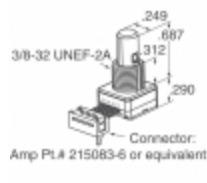
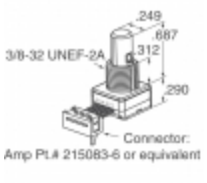
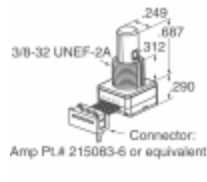
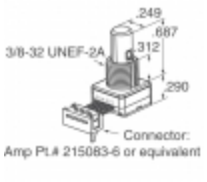
 <p>62S11-H9-040S Producători: Grayhill, Inc. Descriere: ROTARY ENCODER OPTICAL 32PPR In stoc: 2086 pcs RFQ</p>	 <p>62S11-H9-050S Producători: Grayhill, Inc. Descriere: ROTARY ENCODER OPTICAL 32PPR In stoc: 1839 pcs RFQ</p>
 <p>62S11-H9-025S Producători: Grayhill, Inc. Descriere: ROTARY ENCODER OPTICAL 32PPR In stoc: 2155 pcs RFQ</p>	 <p>62S11-H9-040C Producători: Grayhill, Inc. Descriere: ROTARY ENCODER OPTICAL 32PPR In stoc: 1975 pcs RFQ</p>
 <p>62S11-L0-020CH Producători: Grayhill, Inc. Descriere: ROTARY ENCODER OPTICAL 32PPR In stoc: 2105 pcs RFQ</p>	 <p>62S11-L0-040C Producători: Grayhill, Inc. Descriere: ROTARY ENCODER OPTICAL 32PPR In stoc: 2079 pcs RFQ</p>
 <p>62S11-H9-020S Producători: Grayhill, Inc. Descriere: ROTARY ENCODER OPTICAL 32PPR In stoc: 2170 pcs RFQ</p>	 <p>62S11-H9-P Producători: Grayhill, Inc. Descriere: ROTARY ENCODER OPTICAL 32PPR In stoc: 2159 pcs RFQ</p>
 <p>62S11-H9-060SH Producători: Grayhill, Inc. Descriere: ROTARY ENCODER OPTICAL 32PPR In stoc: 1966 pcs RFQ</p>	 <p>62S11-H9-PH Producători: Grayhill, Inc. Descriere: ROTARY ENCODER OPTICAL 32PPR In stoc: 2090 pcs RFQ</p>
 <p>62S11-L0-020C Producători: Grayhill, Inc. Descriere: ROTARY ENCODER OPTICAL 32PPR In stoc: 1839 pcs RFQ</p>	 <p>62S11-H9-020C Producători: Grayhill, Inc. Descriere: ROTARY ENCODER OPTICAL 32PPR In stoc: 2176 pcs RFQ</p>

Copyright © 2020 Distribuitor de încredere al componentelor electronice

E-mail: Info@infinity-electronic.com

Adresa: 17F, clădirea comercială Gaylord, strada Lockhart 114-118, Wan Chai, Hong Kong

