



Grayhill, Inc.

## 62S11-N9-060SH

Număr parc:

62S11-N9-060SH

Producator / Marca:

Grayhill, Inc.

Descrierea produsului

ROTARY ENCODER OPTICAL 32PPR

Foi de date:

 62S11-N9-060SH.pdf

Statutul RoHS

 Plumb fără RoHS / RoHS

Starea stocului

1801 pcs stock

Barca din

Hong Kong

Calea de transport

DHL/Fedex/TNT/UPS/EMS

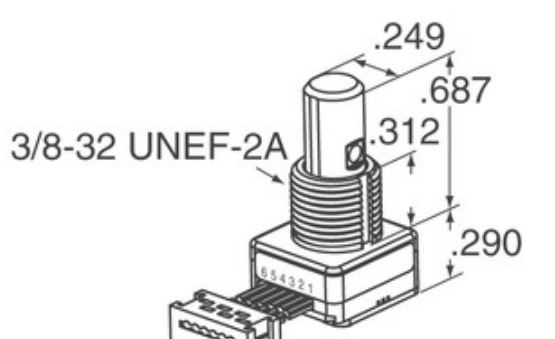

Connector:  
Amp Pt.# 215083-6 or equivalent

Imaginea poate fi reprezentată. Vedeți specificațiile pentru detalii despre produs.





## Specificațiile 62S11-N9-060SH

NUMĂR PARC	62S11-N9-060SH
PRODUCĂTOR	Grayhill, Inc.
DESCRIERE	ROTARY ENCODER OPTICAL 32PPR
CONDIȚII LIBERE DE STARE / STARE ROHS	Plumb fără RoHS / RoHS
CANTITATE VALABILA	1801 pcs
FIȘA CU DATE	 62S11-N9-060SH.pdf
TENSIUNE - APROVIZIONARE	5V
STILUL DE TERMINARE	Cable Leads
SERIE	62S
DURATA DE ROTAȚIE (CICLURI MIN)	1M
IMPULSURI PE REVOLUȚIE	32
TIPUL DE IEȘIRE	Quadrature (Incremental)
ALTE NUME	62S11N9060SH
ORIENTARE	Vertical
TIPUL DE MONTARE	Panel Mount
NIVELUL DE SENSIBILITATE LA UMIDITATE (MSL)	1 (Unlimited)
CONDIȚII DE STARE FĂRĂ PLUMB / STARE ROHS	Lead free / RoHS Compliant
TIPUL ENCODERULUI	Optical
DETENTEI	No
CONSTRUIT ÎN SWITCH	Yes
TIPUL ACTUATORULUI	1/4" Dia Flatted End

## Etichete asemănătoare

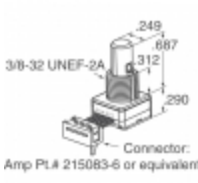
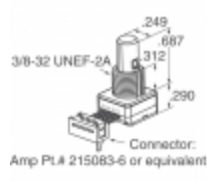
Grayhill, Inc. 62S11-N9-060SH	Distribuitor 62S11-N9-060SH	Furnizor 62S11-N9-060SH
Prețul 62S11-N9-060SH	Imagini 62S11-N9-060SH	Imagine 62S11-N9-060SH
62S11-N9-060SH PDF Datasheet	62S11-N9-060SH Download Datasheet	Fișa tehnică 62S11-N9-060SH
62S11-N9-060SH Stoc	Cumpărați 62S11-N9-060SH	Cumpara Grayhill, Inc. 62S11-N9-060SH
Grayhill, Inc. 62S11-N9-060SH	Furnizor Grayhill, Inc.	Distribuitor Grayhill, Inc.
Grayhill, Inc. 62S11-N9-060SH	Grayhill Inc. 62S11-N9-060SH	

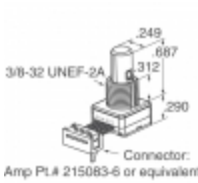
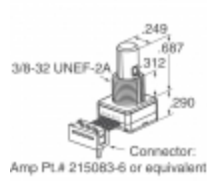
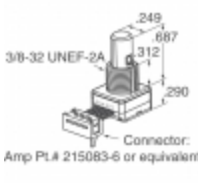
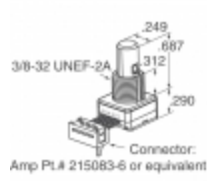
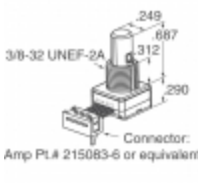
## produse asemanatoare

 <p><b>62S15-H0-020C</b> Producători: Grayhill, Inc. Descriere: ROTARY ENCODER OPTICAL 24PPR In stoc: 2286 pcs</p> <p><b>RFQ</b></p>	 <p><b>62S11-N5-080SH</b> Producători: Grayhill, Inc. Descriere: ROTARY ENCODER OPTICAL 32PPR In stoc: 1942 pcs</p> <p><b>RFQ</b></p>
 <p><b>62S11-N9-PH</b> Producători: Grayhill, Inc. Descriere: ROTARY ENCODER OPTICAL 32PPR In stoc: 2219 pcs</p> <p><b>RFQ</b></p>	 <p><b>62S11-N5-PV</b> Producători: Grayhill, Inc. Descriere: ROTARY ENCODER OPTICAL 32PPR In stoc: 2220 pcs</p> <p><b>RFQ</b></p>
 <p><b>62S15-H0-040C</b> Producători: Grayhill, Inc. Descriere: ROTARY ENCODER OPTICAL 24PPR In stoc: 1793 pcs</p> <p><b>RFQ</b></p>	 <p><b>62S11-N9-120S</b> Producători: Grayhill, Inc. Descriere: ROTARY ENCODER OPTICAL 32PPR In stoc: 1784 pcs</p> <p><b>RFQ</b></p>
 <p><b>62S11-N5-120S</b> Producători: Grayhill, Inc. Descriere: ROTARY ENCODER OPTICAL 32PPR In stoc: 1675 pcs</p> <p><b>RFQ</b></p>	 <p><b>62S11-N5-P</b> Producători: Grayhill, Inc. Descriere: ROTARY ENCODER OPTICAL 32PPR In stoc: 1885 pcs</p> <p><b>RFQ</b></p>
 <p><b>62S11-N9-060C</b> Producători: Grayhill, Inc. Descriere: ROTARY ENCODER OPTICAL 32PPR In stoc: 2192 pcs</p> <p><b>RFQ</b></p>	 <p><b>62S11-N5-100C</b> Producători: Grayhill, Inc. Descriere: ROTARY ENCODER OPTICAL 32PPR In stoc: 1789 pcs</p> <p><b>RFQ</b></p>
 <p><b>62S15-H0-P</b> Producători: Grayhill, Inc. Descriere: ROTARY ENCODER OPTICAL 24PPR In stoc: 2136 pcs</p> <p><b>RFQ</b></p>	 <p><b>62S15-H0-040CH</b> Producători: Grayhill, Inc. Descriere: ROTARY ENCODER OPTICAL 24PPR In stoc: 1921 pcs</p> <p><b>RFQ</b></p>