



Grayhill, Inc.

62S11-N9-PH

Număr parc:

62S11-N9-PH

Producator / Marca:

Grayhill, Inc.

Descrierea produsului

ROTARY ENCODER OPTICAL 32PPR

Foi de date:

 62S11-N9-PH.pdf

Statutul RoHS

 Plumb fără RoHS / RoHS

Starea stocului

2219 pcs stock

Barca din

Hong Kong

Calea de transport

DHL/Fedex/TNT/UPS/EMS

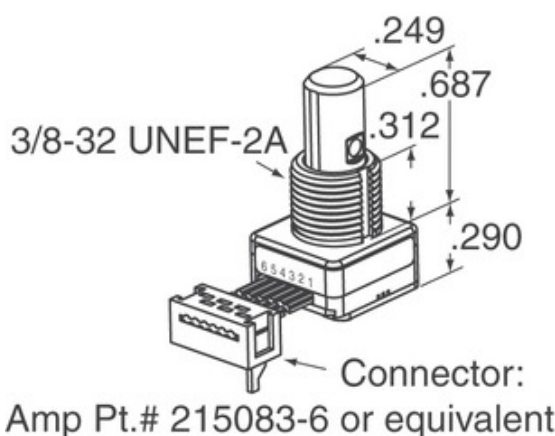

Imaginea poate fi reprezentată. Vedeți specificațiile pentru detalii despre produs.

[CERERE DE OFERTĂ](#)







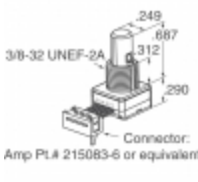
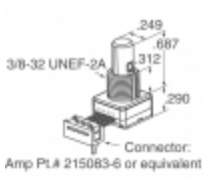

Specificațiile 62S11-N9-PH

NUMĂR PARC	62S11-N9-PH
PRODUCĂTOR	Grayhill, Inc.
DESCRIERE	ROTARY ENCODER OPTICAL 32PPR
CONDIȚII LIBERE DE STARE / STARE ROHS	Plumb fără RoHS / RoHS
CANTITATE VALABILA	2219 pcs
FIȘA CU DATE	 62S11-N9-PH.pdf
TENSIUNE - APROVIZIONARE	5V
STILUL DE TERMINARE	PC Pin
SERIE	62S
DURATA DE ROTAȚIE (CICLURI MIN)	1M
IMPULSURI PE REVOLUȚIE	32
TIPUL DE IEȘIRE	Quadrature (Incremental)
ORIENTARE	Vertical
TIPUL DE MONTARE	PCB, Through Hole
NIVELUL DE SENSIBILITATE LA UMIDITATE (MSL)	1 (Unlimited)
CONDIȚII DE STARE FĂRĂ PLUMB / STARE ROHS	Lead free / RoHS Compliant
TIPUL ENCODERULUI	Optical
DETENTEI	No
CONSTRUIT ÎN SWITCH	Yes
TIPUL ACTUATORULUI	1/4" Dia Flatted End

Etichete asemănătoare

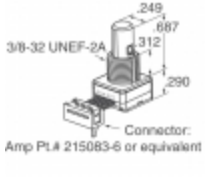
Grayhill, Inc. 62S11-N9-PH	Distribuitor 62S11-N9-PH	Furnizor 62S11-N9-PH
Prețul 62S11-N9-PH	Imagini 62S11-N9-PH	Imagine 62S11-N9-PH
62S11-N9-PH PDF Datasheet	62S11-N9-PH Download Datasheet	Fișa tehnică 62S11-N9-PH
62S11-N9-PH Stoc	Cumpărați 62S11-N9-PH	Cumpara Grayhill, Inc. 62S11-N9-PH
Grayhill, Inc. 62S11-N9-PH	Furnizor Grayhill, Inc.	Distribuitor Grayhill, Inc.
Grayhill, Inc. 62S11-N9-PH	Grayhill Inc. 62S11-N9-PH	

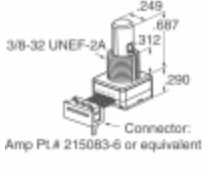
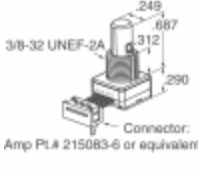
produse asemanatoare

 <p>62S15-H0-020C Producători: Grayhill, Inc. Descriere: ROTARY ENCODER OPTICAL 24PPR In stoc: 2286 pcs</p> <p>RFQ</p>	 <p>62S11-N9-060C Producători: Grayhill, Inc. Descriere: ROTARY ENCODER OPTICAL 32PPR In stoc: 2192 pcs</p> <p>RFQ</p>
 <p>62S11-N9-060SH Producători: Grayhill, Inc. Descriere: ROTARY ENCODER OPTICAL 32PPR In stoc: 1801 pcs</p> <p>RFQ</p>	 <p>62S15-H0-PH Producători: Grayhill, Inc. Descriere: ROTARY ENCODER OPTICAL 24PPR In stoc: 2290 pcs</p> <p>RFQ</p>
 <p>62S11-N5-PV Producători: Grayhill, Inc. Descriere: ROTARY ENCODER OPTICAL 32PPR In stoc: 2220 pcs</p> <p>RFQ</p>	 <p>62S15-H0-040CH Producători: Grayhill, Inc. Descriere: ROTARY ENCODER OPTICAL 24PPR In stoc: 1921 pcs</p> <p>RFQ</p>
 <p>62S11-N9-120S Producători: Grayhill, Inc. Descriere: ROTARY ENCODER OPTICAL 32PPR In stoc: 1784 pcs</p> <p>RFQ</p>	 <p>62S15-H9-020C Producători: Grayhill, Inc. Descriere: ROTARY ENCODER OPTICAL 24PPR In stoc: 1833 pcs</p> <p>RFQ</p>
 <p>62S11-N5-120S Producători: Grayhill, Inc. Descriere: ROTARY ENCODER OPTICAL 32PPR In stoc: 1675 pcs</p> <p>RFQ</p>	 <p>62S11-N5-P Producători: Grayhill, Inc. Descriere: ROTARY ENCODER OPTICAL 32PPR In stoc: 1885 pcs</p> <p>RFQ</p>
 <p>62S15-H0-P Producători: Grayhill, Inc. Descriere: ROTARY ENCODER OPTICAL 24PPR In stoc: 2136 pcs</p> <p>RFQ</p>	 <p>62S15-H0-040C Producători: Grayhill, Inc. Descriere: ROTARY ENCODER OPTICAL 24PPR In stoc: 1793 pcs</p> <p>RFQ</p>

Copyright © 2020 Distribuitor de încredere al componentelor electronice

E-mail: Info@infinity-electronic.com

Adresa: 17F, clădirea comercială Gaylord, strada Lockhart 114-118, Wan Chai, Hong Kong

